

colour bar wall cabinet II

#8865

COLOUR BAR WALL CABINET II

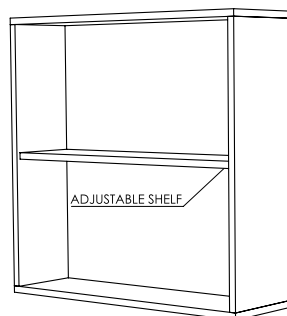

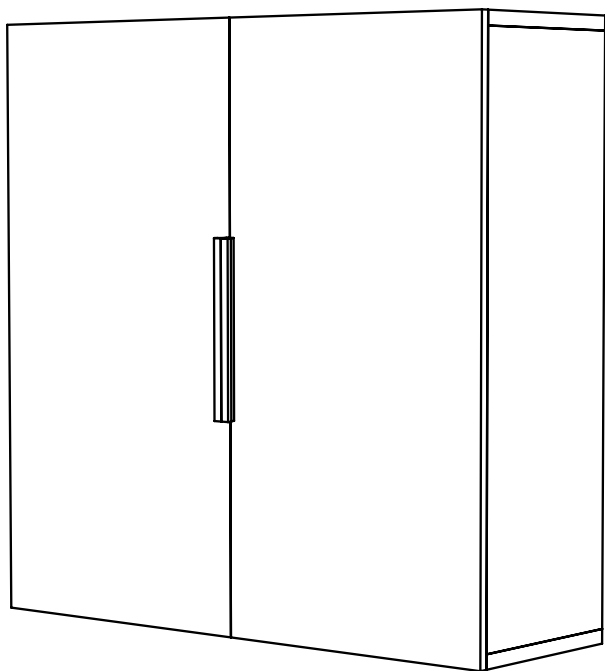

IMPORTANT PLEASE READ THESE SAFETY INSTRUCTIONS

GENERAL SAFETY

1. Read carefully and keep these instructions in a safe place.
2. Use this product only for its intended function and do not use attachments not recommended by the manufacturer.
3. Do not use outdoors.

GET STARTED

COLOUR BAR

A dedicated colour area

With our customised Colour Bar Area you can choose your preferred combo set that creates an area that can be incorporated into the salon.

Easily organise your range of colours in a professional way, with ample storage, a stainless steel sink option with a black textured wood grain finish.

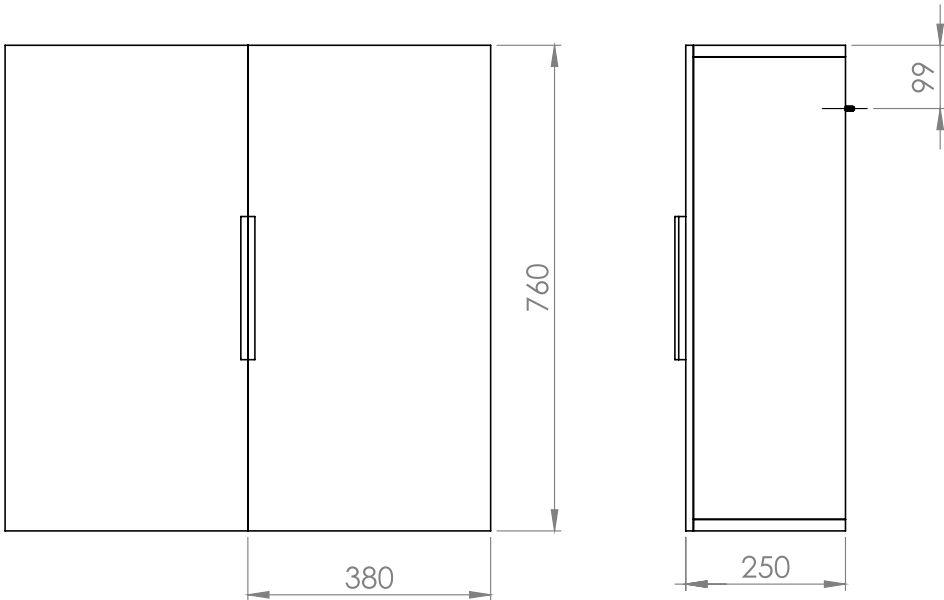

CLEANING

GENERAL CLEANING

- We recommend the use of soapy water or approved cleaners.
- This product should not be cleaned with abrasive materials.
- Damage caused by any improper treatment is not covered by the product warranty

MAINTENANCE

A periodic inspection of all components and fasteners should be made to ensure that your Comfortel product is structurally intact and functioning properly.

Damaged and broken parts should be replaced and loose fasteners tightened.

All maintenance to be carried out by a suitably qualified tradesperson.

INSTALLATION: WALL CABINET

STEP 1: POSITION

Wall

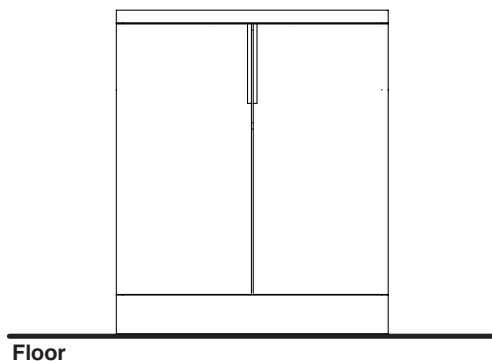
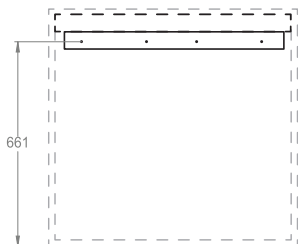

STEP 2

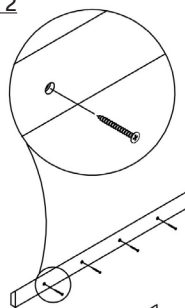

STEP 3

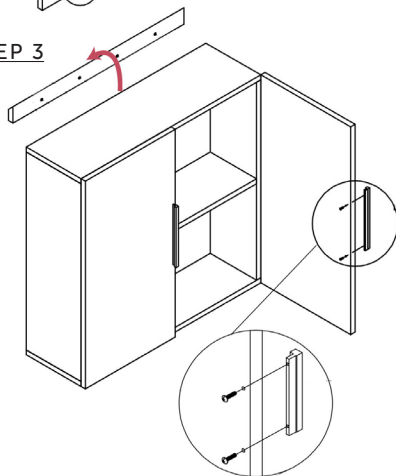

INSTALL THE WALL CABINETS

Step 1: Position wall cabinet bracket
Step 2: Drill holes in wall unit to suit and use secure to wall.

Please note: Screws to mount not supplied.
Step 3: Hook Cabinet into place and attach handles to each door.

IMPORTANT

WALL FIXINGS NOT SUPPLIED. PLEASE REFER TO WALL CABINET WEIGHT WHEN INSTALLING TO DETERMINE BEST PRACTICE MOUNTING. WALL STUDS & NOGGINS ARE NOT REQUIRED WHEN INSTALLING.



FINAL

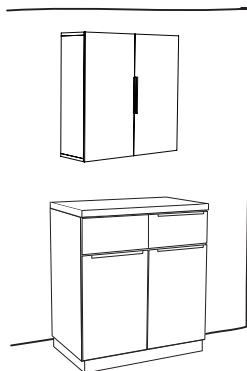

PLEASE USE CORRECT FIXTURES FOR MOUNTING BASED ON WALL TYPE. NO RESPONSIBILITY IS ACCEPTED FOR ANY DAMAGE OR INJURY CAUSED BY INCORRECT MOUNTING.

COLOUR BAR POSITIONING & SIZE

Open each box and position the colour bar in your salon or space, allowing for height of top units.
Colour Bar Cabinets must be fixed to a wall. Allow for the necessary room in front of the unit for access.

SIDE VIEW

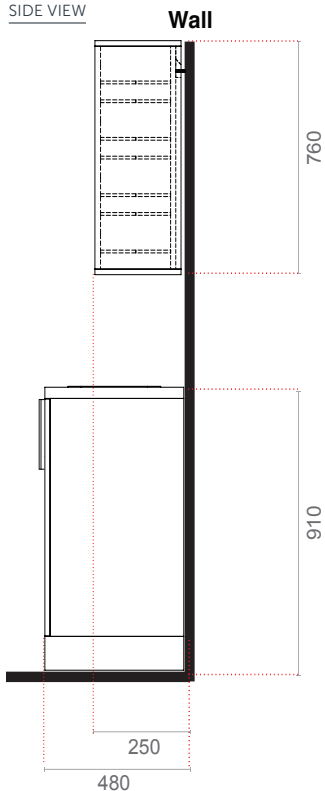

FRONT VIEW

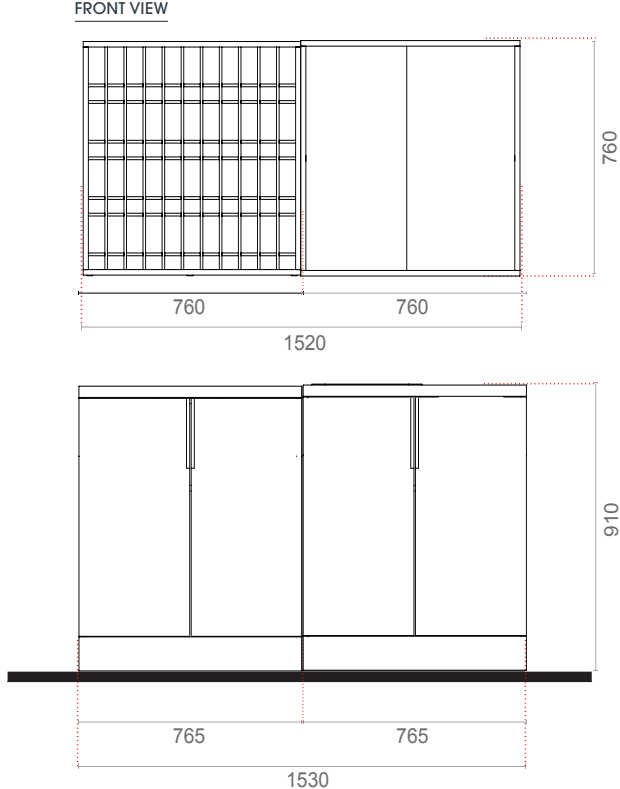

comfortel

help.comfortel.com.au

PRODUCT CODE

#8865 COLOUR BAR WALL CABINET II

Revision Date: 24.11.2020

©Comfortel Furniture. All rights are reserved. No part of this document may be photocopied, reproduced or translated to another language without written consent of Comfortel Furniture Pty Ltd.

The information contained in this document is subject to change without notice and should not be construed as a commitment by Comfortel Furniture Pty Ltd.

Comfortel Furniture Pty Ltd. assumes no responsibility for any errors that may appear in this document nor does it make expressed or implied warranty of any kind with regard to this material, including, but not limited to, the implied warranties of merchantability and fitness for a particular purpose.

Comfortel Furniture Pty Ltd. shall not be liable for incidental or consequential damages in connection with or arising out of the use of this document and the program material.

PLEASE RETAIN THIS INFORMATION FOR FUTURE REFERENCE

For more information about our products and services, contact us at comfortel.com.au

WARRANTY PERIOD

TERMS AND CONDITIONS. For more information about our warranty, please refer to our website.

PURCHASE DATE

INVOICE NUMBER

NOTE YOUR PURCHASE DATE & INVOICE NUMBER FOR FUTURE REFERENCE