

pallazio workstation

#8055

PALLAZIO SALON WORKSTATION/MIRROR

GET STARTED

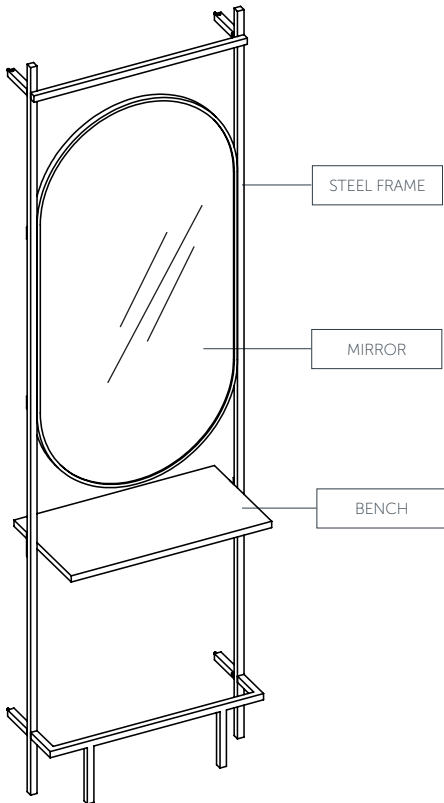

All measurements are in mm (inches).

PALLAZIO

Steel Salon Workstation

Width: 660mm (26") **Height:** 2320mm (91.3")



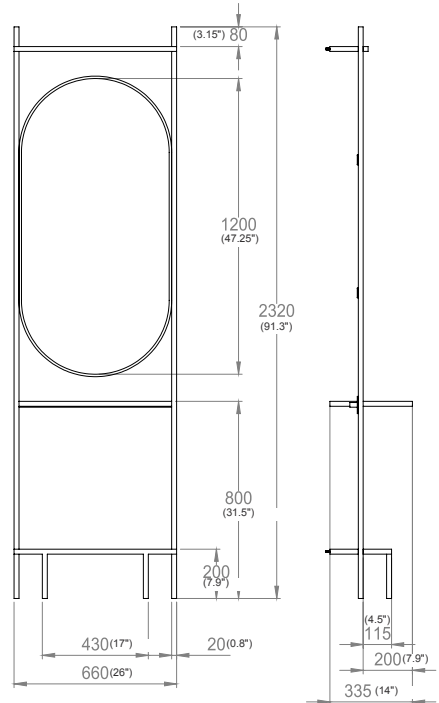

Depth: 335mm (14") **Weight:** 15Kg (33lbs)



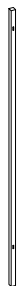





Material: Black steel frame and bench



ASSEMBLY

No.	Part List	Qty
A		2

No.	Part List	Qty
B		1
C		1
D		2
E		1

No.	Part List	Qty
F		1
G(L)/G(R)	 	2/2
H		1
I		4
J		12
K		12
O		4
M		1

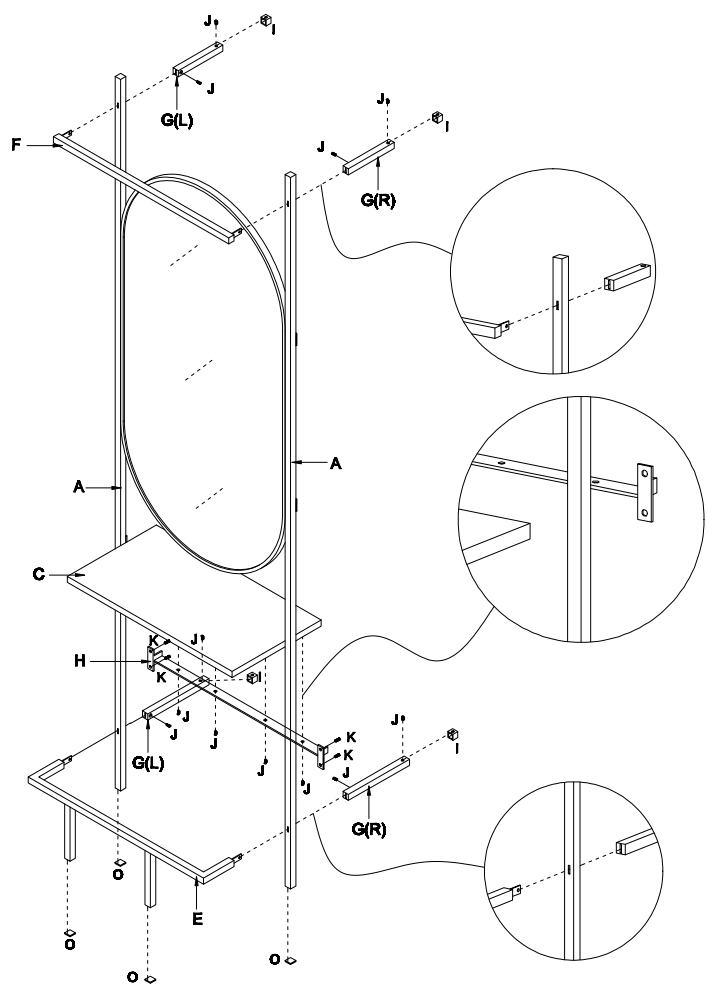
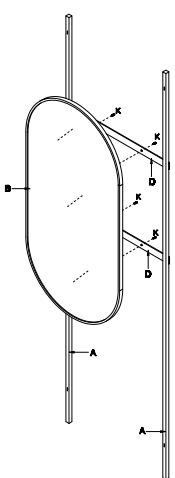
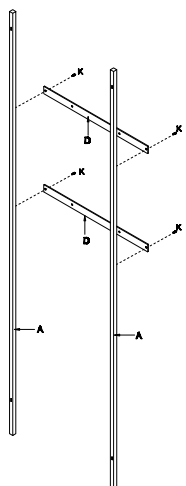

INSTALLATION: RECOMMENDED WALL MOUNTING

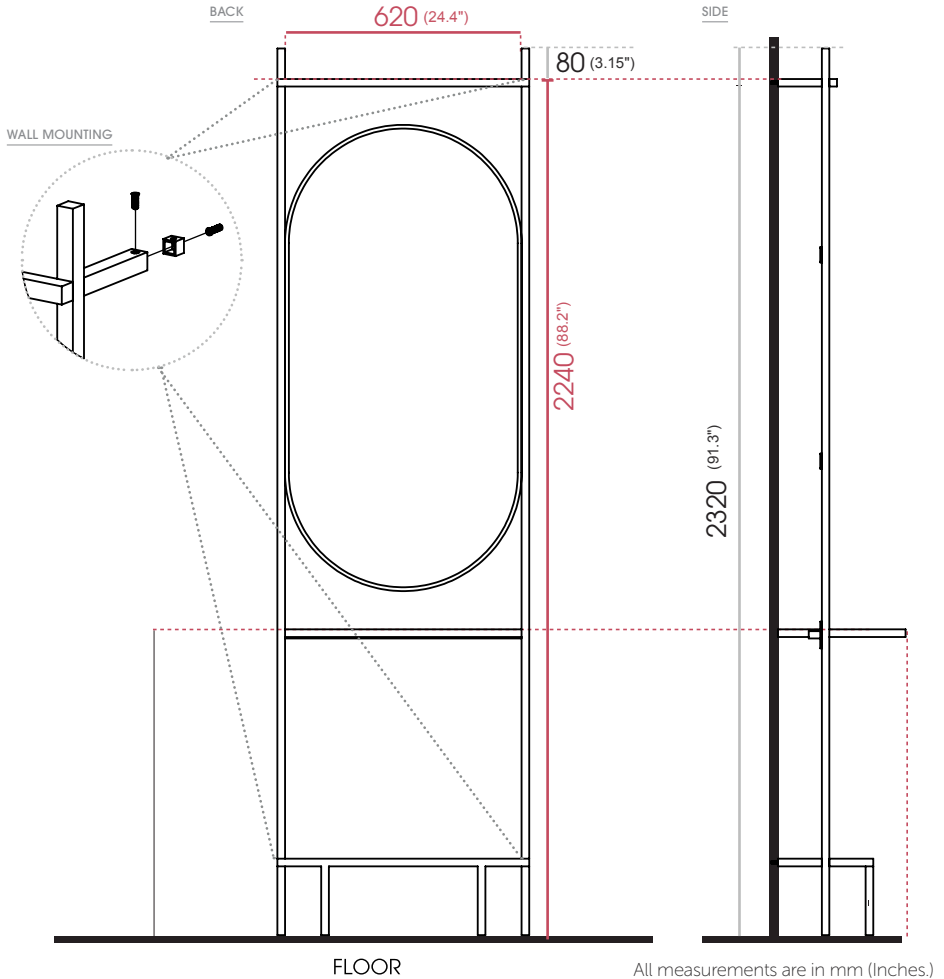

BEFORE INSTALLING YOU SHOULD CONSIDER THE FOLLOWING:

Allow for the necessary room around the unit for free movement. When installing, position bench so it is 800mm - 850mm (31.5" - 33") from the floor. This is the recommended bench height.

MOUNTING TO WALL

1. Position frame as pictured
2. Using fixings (Not supplied), secure frame to wall

IMPORTANT

WALL FIXINGS NOT SUPPLIED.
PLEASE REFER TO MIRROR WEIGHT
WHEN INSTALLING TO DETERMINE BEST
PRACTICE MOUNTING.
WALL STUDS AND NOGGINS ARE NOT
REQUIRED WHEN INSTALLING MIRRORS



PLEASE USE CORRECT FIXTURES FOR MOUNTING BASED ON WALL TYPE. NO RESPONSIBILITY IS ACCEPTED FOR ANY DAMAGE OR INJURY CAUSED BY INCORRECT MOUNTING.



IMPORTANT PLEASE READ THESE SAFETY INSTRUCTIONS

GENERAL SAFETY

1. Read carefully and keep these instructions in a safe place.
2. Use this product only for its intended function and do not use attachments not recommended by the manufacturer.
3. Do not use outdoors.



IMPORTANT

WALL FIXINGS NOT SUPPLIED. PLEASE REFER TO MIRROR WEIGHT WHEN INSTALLING TO DETERMINE BEST PRACTICE MOUNTING. WALL STUDS AND NOGGINS ARE NOT REQUIRED WHEN INSTALLING MIRRORS



PLEASE USE CORRECT FIXTURES FOR MOUNTING BASED ON WALL TYPE. NO RESPONSIBILITY IS ACCEPTED FOR ANY DAMAGE OR INJURY CAUSED BY INCORRECT MOUNTING.

CLEANING

GENERAL CLEANING

- We recommend the use of soapy water or approved cleaners.
- This product should not be cleaned with abrasive materials.
- Damage caused by any improper treatment is not covered by the product warranty

MAINTENANCE

A periodic inspection of all components and fasteners should be made to ensure that your Comfortel product is structurally intact and functioning properly.

Damaged and broken parts should be replaced and loose fasteners tightened.

All maintenance to be carried out by a suitably qualified tradesperson.

comfortel

help.comfortel.com.au

PRODUCT CODE

#8055 PALLAZIO WORKSTATION

Revision Date: V2.11.08.2020

©Comfortel Furniture. All rights are reserved. No part of this document may be photocopied, reproduced or translated to another language without written consent of Comfortel Furniture Pty Ltd.

The information contained in this document is subject to change without notice and should not be construed as a commitment by Comfortel Furniture Pty Ltd.

Comfortel Furniture Pty Ltd. assumes no responsibility for any errors that may appear in this document nor does it make expressed or implied warranty of any kind with regard to this material, including, but not limited to, the implied warranties of merchantability and fitness for a particular purpose.

Comfortel Furniture Pty Ltd. shall not be liable for incidental or consequential damages in connection with or arising out of the use of this document and the program material.

PLEASE RETAIN THIS INFORMATION FOR FUTURE REFERENCE

For more information about our products and services, contact us at comfortel.com.au

WARRANTY PERIOD

TERMS AND CONDITIONS. For more information about our warranty, please refer to our website.

PURCHASE DATE

INVOICE NUMBER

NOTE YOUR PURCHASE DATE & INVOICE NUMBER FOR FUTURE REFERENCE