

# lionel retail shelves

#7403

LIONEL

---

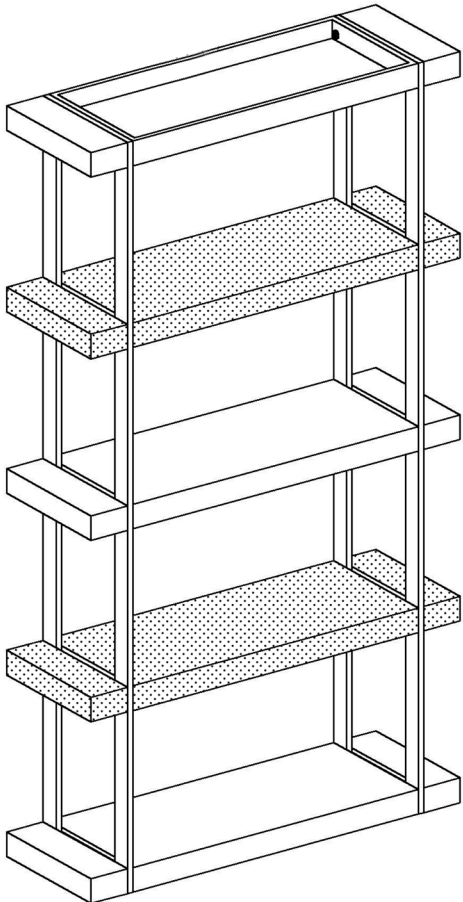



## IMPORTANT PLEASE READ THESE SAFETY INSTRUCTIONS

### GENERAL SAFETY

1. Read carefully and keep these instructions in a safe place.
2. Use this product only for its intended function and do not use attachments not recommended by the manufacturer.
3. Do not use outdoors.

### GET STARTED

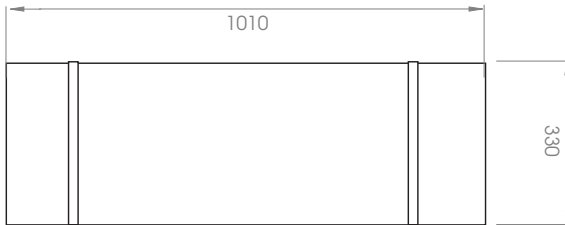

### LIONEL

Retail Shelves



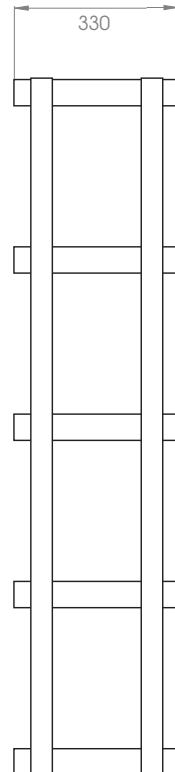
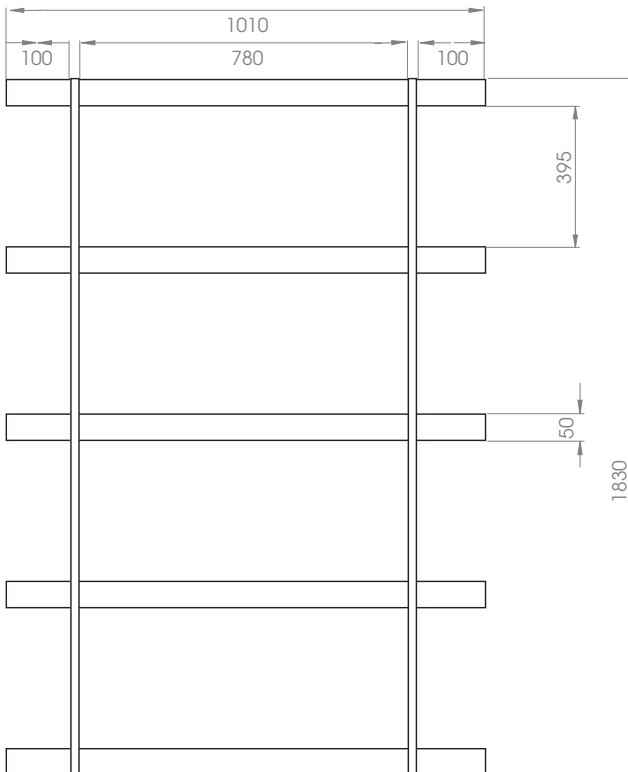

Colour: Concrete Look Finish, Gloss White



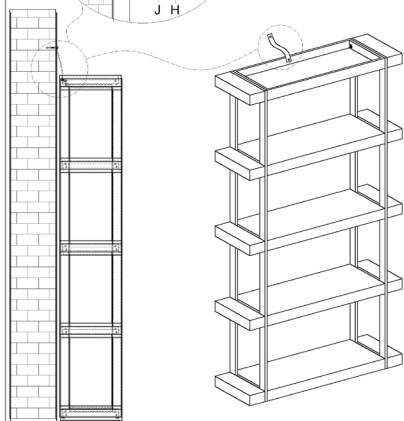
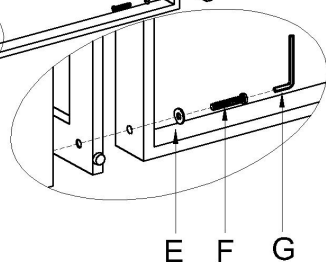
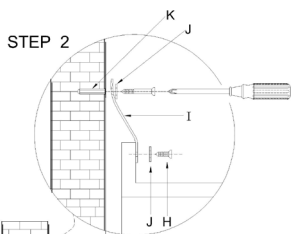
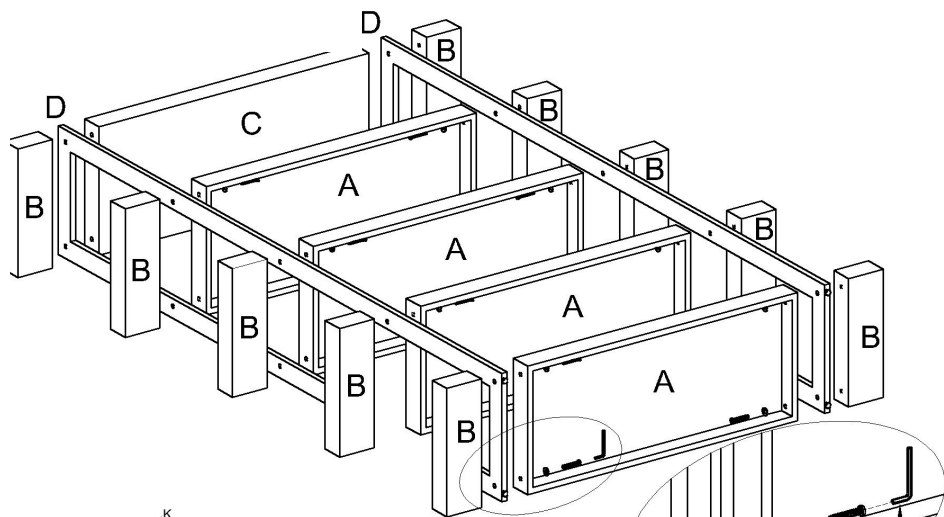









All measurements are in MM.

# INSTALLATION & ASSEMBLY



L	K
	
Ø6*30	Ø6*30
1PC	1PC
I	J
	
150mm	φ6/φ13
1PC	2PCS

A	B	C	D	E	F	G	H	I	J
									
4PCS	10PCS	1PC	2PCS	Ø8/Ø19*2	M8*50	5mm	φ4*12	150mm	φ6/φ13
				20PCS	20PCS	1PC	1PC	1PC	2PCS

## CLEANING

### GENERAL CLEANING

- We recommend the use of soapy water or approved cleaners.
- This product should not be cleaned with abrasive materials.
- Damage caused by any improper treatment is not covered by the product warranty

## MAINTENANCE

A periodic inspection of all components and fasteners should be made to ensure that your Comfortel product is structurally intact and functioning properly.

Damaged and broken parts should be replaced and loose fasteners tightened.

All maintenance to be carried out by a suitably qualified tradesperson.

# comfortel

[help.comfortel.com.au](http://help.comfortel.com.au)

### PRODUCT CODE

#7403 LIONEL RETAIL SHELVES

Revision Date: 14.06.2018

©Comfortel Furniture 1997-2018. All rights are reserved.  
No part of this document may be photocopied, reproduced or translated to another language without written consent of Comfortel Furniture Pty Ltd.

The information contained in this document is subject to change without notice and should not be construed as a commitment by Comfortel Furniture Pty Ltd.

Comfortel Furniture Pty Ltd. assumes no responsibility for any errors that may appear in this document nor does it make expressed or implied warranty of any kind with regard to this material, including, but not limited to, the implied warranties of merchantability and fitness for a particular purpose.

Comfortel Furniture Pty Ltd. shall not be liable for incidental or consequential damages in connection with or arising out of the use of this document and the program material.

### **PLEASE RETAIN THIS INFORMATION FOR FUTURE REFERENCE**

For more information about our products and services, contact us at [comfortel.com.au](http://comfortel.com.au)

**PURCHASE DATE**

**INVOICE NUMBER**

**NOTE YOUR PURCHASE DATE & INVOICE NUMBER FOR FUTURE REFERENCE**