

# clara salon trolley

#7026

CLARA 2 DRAWER TROLLEY - WHITE

---

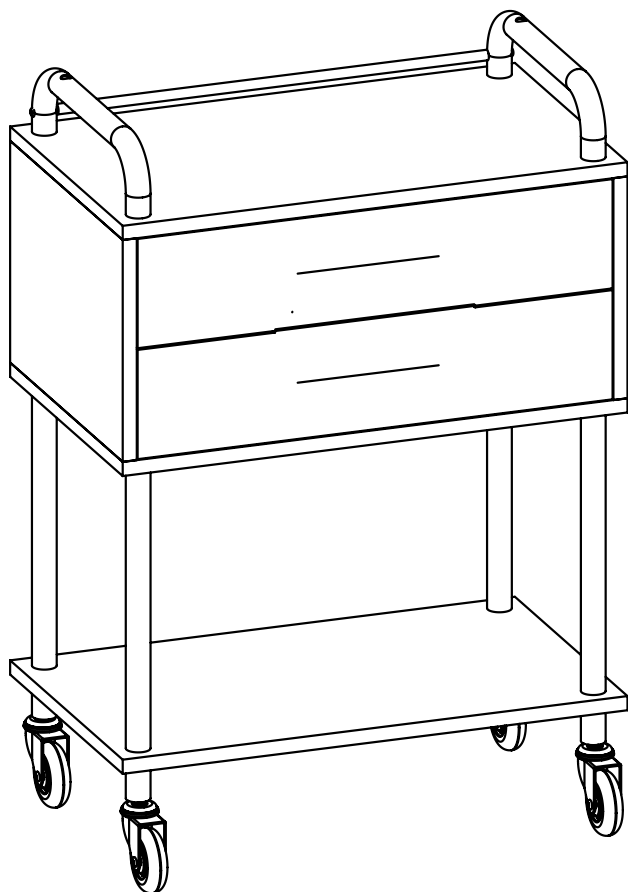



## IMPORTANT PLEASE READ THESE SAFETY INSTRUCTIONS

### GENERAL SAFETY

1. Read carefully and keep these instructions in a safe place.
2. Use this product only for its intended function and do not use attachments not recommended by the manufacturer.
3. Do not use outdoors.

## GET STARTED

### CLARA

Salon Trolley

Material: White Steel Frame, Melamine Shelves



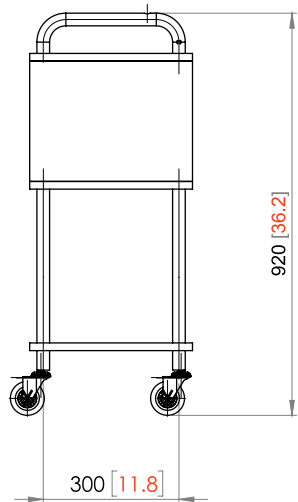
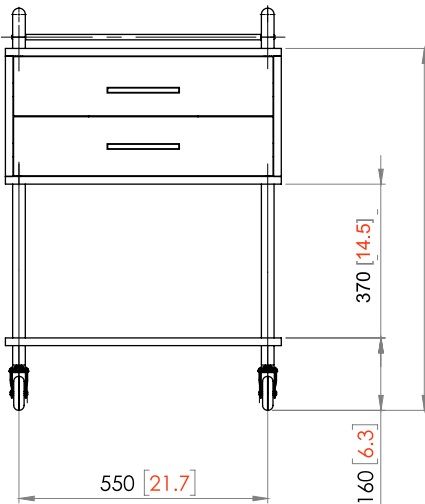
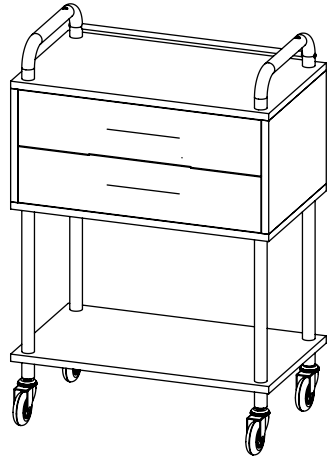
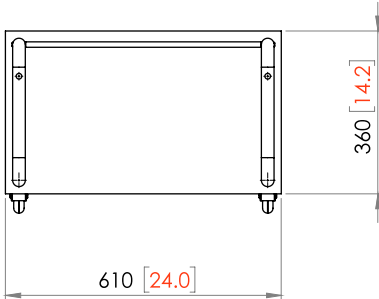

Wheels: 75mm Smooth Rolling Wheels

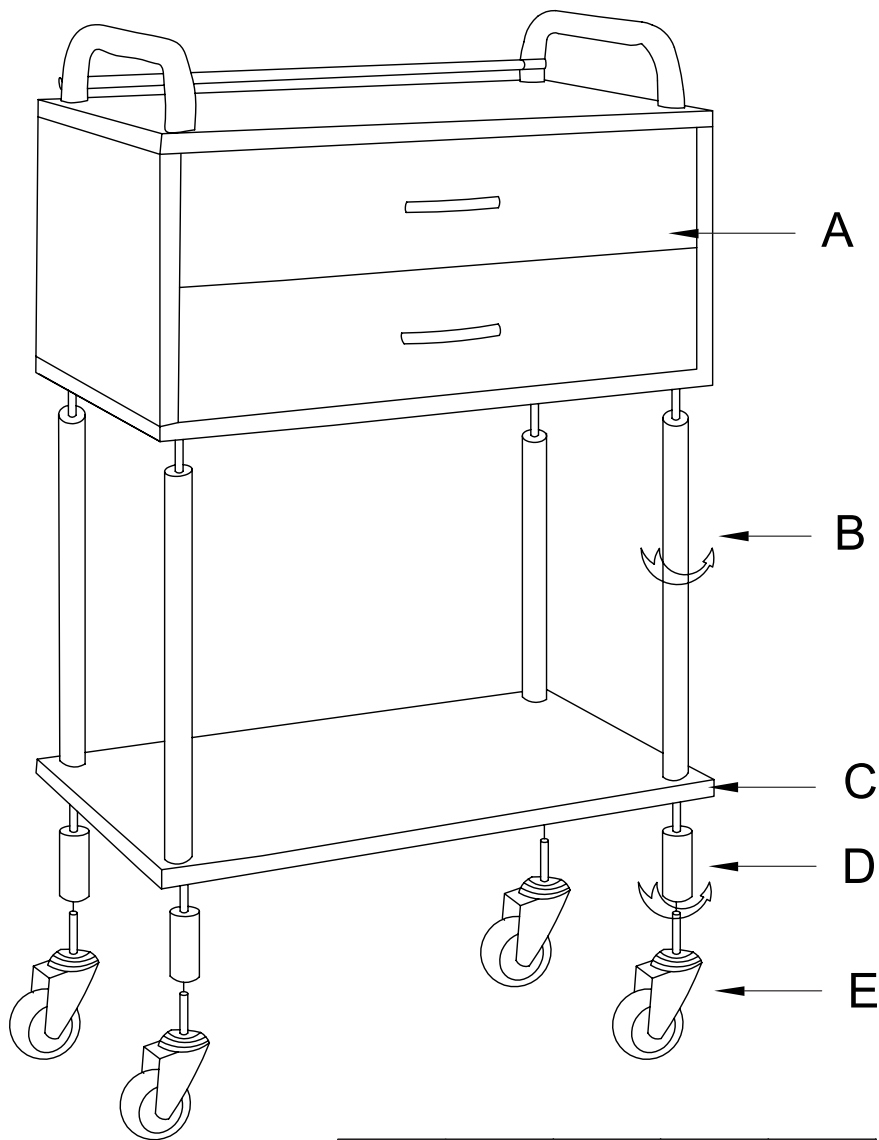

All measurements are in mm [inches]

# INSTALLATION & ASSEMBLY



A	B	C	D	E
				
1PC	4PCS	1PC	4PCS	4PCS

## CLEANING

### GENERAL CLEANING

- We recommend the use of soapy water or approved cleaners.
- This product should not be cleaned with abrasive materials.
- Damage caused by any improper treatment is not covered by the product warranty

## MAINTENANCE

A periodic inspection of all components and fasteners should be made to ensure that your Comfortel product is structurally intact and functioning properly.

Damaged and broken parts should be replaced and loose fasteners tightened.

All maintenance to be carried out by a suitably qualified tradesperson.

# comfortel

[help.comfortel.com.au](http://help.comfortel.com.au)

### PRODUCT CODE

#7026 CLARA 2 DRAWER SALON TROLLEY

Revision Date: 31.03.2021

©Comfortel Furniture. All rights are reserved. No part of this document may be photocopied, reproduced or translated to another language without written consent of Comfortel Furniture Pty Ltd.

The information contained in this document is subject to change without notice and should not be construed as a commitment by Comfortel Furniture Pty Ltd.

Comfortel Furniture Pty Ltd. assumes no responsibility for any errors that may appear in this document nor does it make expressed or implied warranty of any kind with regard to this material, including, but not limited to, the implied warranties of merchantability and fitness for a particular purpose.

Comfortel Furniture Pty Ltd. shall not be liable for incidental or consequential damages in connection with or arising out of the use of this document and the program material.

### **PLEASE RETAIN THIS INFORMATION FOR FUTURE REFERENCE**

For more information about our products and services, contact us at [comfortel.com.au](http://comfortel.com.au)

### WARRANTY PERIOD

TERMS AND CONDITIONS. For more information about our warranty, please refer to our website.

PURCHASE DATE

INVOICE NUMBER

NOTE YOUR PURCHASE DATE & INVOICE NUMBER FOR FUTURE REFERENCE